



SMART X96-1A-MT

Smart Energy Analyzer for Single and Three Phase Electrical Systems



- Measures kWh, kVarh, kW, kVar, kVA, P, F, PF, Hz, dmd, V, A, etc.
- Bi-directional Measurement IMP & EXP
- Energy Information of Each Phase
- Two Pulse Outputs
- RS485 Modbus RTU
- Total Harmonic Distortion of Voltage and Current
- 2nd~63rd Individual Harmonic Distortion
- Backlit LCD Display for Full Viewing Angles
- Class 1 , Class 0.5S
- Bar Graph for Power Indication
- Dimension 96x96mm
- Multi-tariff
- RJ-12 333mV or 100mA CT input

Introduction

The multifunction energy analyzer SMART X96 series is a top new-generation intelligent panel meter, used not only in the electricity transmission and power distribution system, but also in the power consumption measurement and analysis in high voltage intelligent power grid.

This document provides operating, maintenance and installation instructions for the Eastron SMART X96 series. The unit measures and displays the characteristics of single phase two wire, three phase three wire and three phase four wire supplies, including voltage, frequency, current, power and active and reactive energy, imported or exported, Harmonic, Power factor, Max. Demand etc. Energy is measured in terms of kWh, kVAh. Maximum demand current can be measured over preset periods of up to 60 minutes. In order to measure energy, the unit requires voltage and current inputs for the supply required to power the product. The requisite current input(s) are obtained via current transformers The SMART X96 can be configured to work with a wide range of CTs, giving the unit a wide range of operation. Built-in interfaces provide pulse and RS485 Modbus RTU outputs. Configuration is password protected.

1. Unit Characteristics

1.1 The Unit can measure and display:

- Line voltage and THD% (total harmonic distortion) of all phases
- 2~63rd voltage IHD% (Individual Harmonic distortion) of all phases
- Line Frequency
- Phase Sequence
- Currents, Current demands and current THD% of all phases
- 2~63rd current IHD% of all phases
- Active power, reactive power, apparent power, maximum power demand and power factor
- Active energy imported and exported
- Reactive energy imported and exported
- Energy of each phase
- Multi Tariff active energy

1.2 The unit has password-protected set-up screens for:

- **Communication setting:** Modbus address, Baud rate, Parity, Stop bit
- **CT setting:** CT 1 (Primary)
- **PT setting:** PT1 (Primary)
- **Pulse setting:** Pulse output 1, Pulse rate, Pulse time
- **Demand setting:** Demand interval time, demand method
- **Time setting:** Backlit time, display scroll time
- **System configuration:** System type, System connect, Change password, Auto display scroll
- **Reset**

1.3 CT and PT

CT1 (primary current): 5~9999A

CT2 (secondary current): 100mA

PT1 (primary voltage): 100V ~ 500,000V

PT2 (secondary voltage): 100 to 480 V AC (L-L)

Current Transformer ESCT-RJ series is part of the “Easy wiring” metering solution, used for Smart X96-1 with RJ12 socket for fast connection. Smart X96-1, ESCT-RJ series and pre-manufactured wiring looms combine a complete solution.

ESCT-RJ335 Model Options:

Model	Primary current	VA at Class 0.5/ 1.0
ESCT-RJ335-100A/100mA/333mV	100A	0.2
ESCT-RJ335-200A/100Ma/333mV	200A	0.2

1.4 RS485 Serial-Modbus RTU

This unit uses a RS485 serial port with Modbus RTU protocol to provide a means of remote monitoring and controlling. Please check the Part 4.2 for the details of setting.

1.5 Pulse output

Two pulse outputs indicate real-time energy measurement. Pulse output 1 is configurable, pulse output 2 is fixed to active energy, 3200imp/kWh.



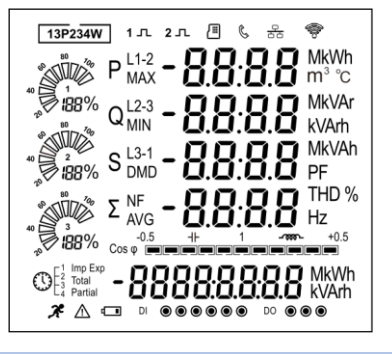
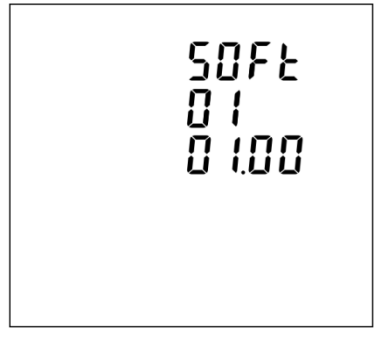
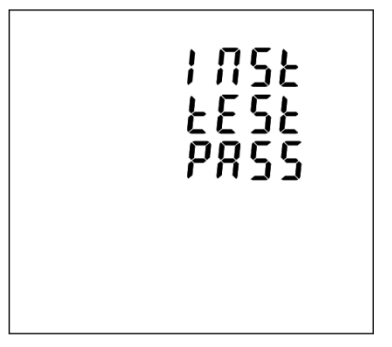

2 . Start up screens

	<p>The first screen lights all LED segments and can be used as a display LED check</p>
	<p>The second screen indicates the software version of the unit. (the left picture is just for reference)</p>
	<p>The unit performs a self-test and the screen indicates if the test is passed.</p>

After a short delay, the default measurement screen appears.



3 . Buttons and Displays

3.1 Buttons Function

Buttons	Click	Press 2S
	<ul style="list-style-type: none"> ➤ Displays power, voltage, current and energy information of each phase ➤ Escape the menu 	<ul style="list-style-type: none"> ➤ Automatic Scroll display ON / OFF
	<ul style="list-style-type: none"> ➤ Display Voltage and current information of the selected system type. (3p4w, 3p3w and 1p2w) ➤ Phase sequence ➤ Left side move 	<ul style="list-style-type: none"> ➤ Individual Harmonic Distortion of Voltage up to 63rd
	<ul style="list-style-type: none"> ➤ Display power factor, frequency, Max. Demand. ➤ Up page or add value 	<ul style="list-style-type: none"> ➤ Individual Harmonic Distortion of Current up to 63rd
	<ul style="list-style-type: none"> ➤ Display active power, reactive power and apparent power information of the selected system type. ➤ Down page or reduce value 	<ul style="list-style-type: none"> ➤ Running hour ➤ Full screen checking
	<ul style="list-style-type: none"> ➤ Display total / import / export active or reactive energy information of the selected system type. ➤ 4 tariff energy and RTC ➤ Right side move 	<ul style="list-style-type: none"> ➤ Set-up mode entry ➤ Confirmation





3.2 Display Mode Screen Sequence

Click button	3 Phase 4 Wire		3 Phase 3 Wire		1 Phase 2 Wire	
	Screen	Parameters	Screen	Parameters	Screen	Parameters
	1	Phase 1 – Power Voltage Current kWh	1	Phase 1 – Power Current kWh	1	Phase 1 – Power Voltage Current kWh
	2	Phase 2 – Power Voltage Current kWh	2	Phase 2 – Power Current kWh		
	3	Phase 3 – Power Voltage Current kWh	3	Phase 3 – Power Current kWh		

	4	Phase 1 – Power Voltage Current kVarh	4	Phase 1 – Power Current kVarh	2	Phase 1 – Power Voltage Current kVarh
	5	Phase 2 – Power Voltage Current kVarh	5	Phase 2 – Power Current kVarh		
	6	Phase 3 – Power Voltage Current kVarh	6	Phase 3 – Power Current kVarh		
	1	Voltage L1-N Voltage L2-N Voltage L3-N			1	Voltage L1-N
	2	Voltage L1-L2 Voltage L2-L3 Voltage L3-L1	1	Voltage L1-L2 Voltage L2-L3 Voltage L3-L1		
	3	Current L1 Current L2 Current L3 Current Neutral	2	Current L1 Current L2 Current L3	2	Current L1
	4	THD% of Voltage L1 THD% of Voltage L2 THD% of Voltage L3	3	THD% of Voltage L1-2 THD% of Voltage L2-3 THD% of Voltage L3-1	3	THD% of Voltage L1
	5	THD% of Current L1 THD% of Current L2 THD% of Current L3	4	THD% of Current L1 THD% of Current L2 THD% of Current L3	4	THD% of Current L1
	6	Phase Sequence	5	Phase Sequence		
	1	Total Power Factor Frequency	1	Total Power Factor Frequency	1	Total Power Factor Frequency
	2	PF L1 PF L2 PF L3	2	PF L1 PF L2 PF L3		
	3	Max. DMD of Current L1 Max. DMD of Current L2 Max. DMD of Current L3	3	Max. DMD of Current L1 Max. DMD of Current L2 Max. DMD of Current L3	2	Max. DMD of Current L1
	4	Max. DMD of W Max. DMD of Var Max. DMD of VA	4	Max. DMD of W Max. DMD of Var Max. DMD of VA	3	L1 Max. DMD of W L1 Max. DMD of Var L1 Max. DMD of VA
	1	Active Power L1 Active Power L2 Active Power L3	1	Active Power L1 Active Power L2 Active Power L3		

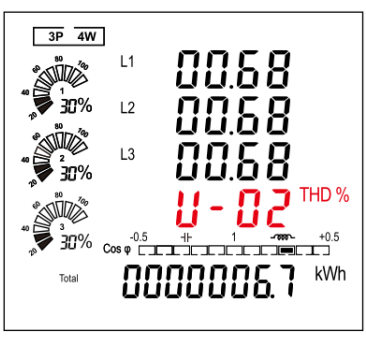
	2	Reactive Power L1 Reactive Power L2 Reactive Power L3	2	Reactive Power L1 Reactive Power L2 Reactive Power L3		
	3	Apparent Power L1 Apparent Power L2 Apparent Power L3	3	Apparent Power L1 Apparent Power L2 Apparent Power L3		
	4	Total Active Power Total Reactive Power Total Apparent Power	4	Total Active Power Total Reactive Power Total Apparent Power	1	L1 Active Power L1 Reactive Power L1 Apparent Power
	1	Total kWh	1	Total kWh	1	Total kWh
	2	Total kVarh	2	Total kVarh	2	Total kVarh
	3	Import kWh	3	Import kWh	3	Import kWh
	4	Export kWh	4	Export kWh	4	Export kWh
	5	Import kVarh	5	Import kVarh	5	Import kVarh
	6	Export KVarh	6	Export KVarh	6	Export KVarh
	7	T1 kWh	7	T1 kWh	7	T1 kWh
	8	T2 kWh	8	T2 kWh	8	T2 kWh
	9	T3 kWh	9	T3 kWh	9	T3 kWh
	10	T4 kWh	10	T4 kWh	10	T4 kWh
	11	Date	11	Date	11	Date
	12	Time	12	Time	12	Time

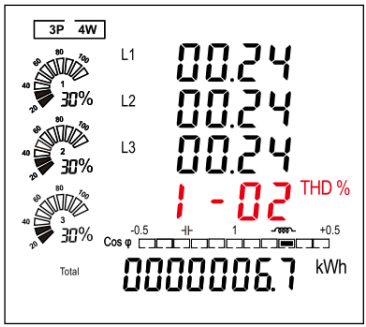
3.3 Individual Harmonic Distortion:

	<p>Press the button  for 2 seconds to check Harmonic distortion of Voltage 2~63rd Harmonic Distortion of Voltage</p>
	<p>Press the button  for 2 seconds to check Harmonic distortion of Current 2~63rd Harmonic Distortion of Current</p>

4. Setting-Up

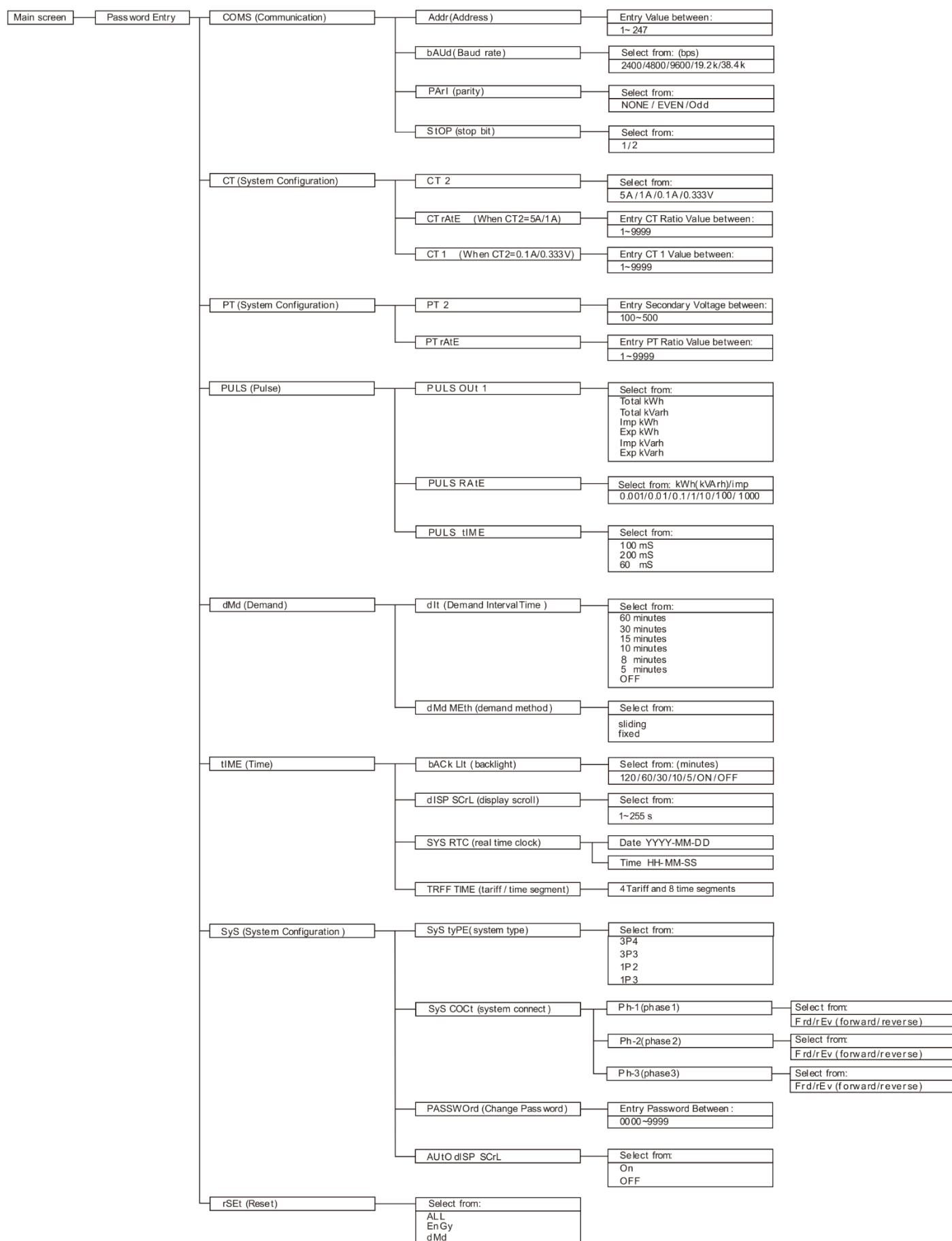





4.1 Password Entry

<p>The LCD display shows the word 'PASS' in the top line and the number '1000' in the bottom line. The '1' in '1000' is red.</p>	<p>Setting-up mode is password protected, so you must enter the correct password. By firmly press the button  for 2 seconds, the password screen appears. The default password is 1000. If an incorrect password is entered, the display shows ERR.</p>
--	--







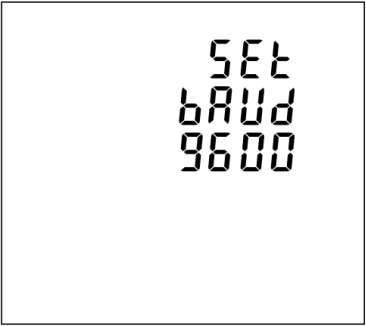

4.2 Communication

<p>The LCD display shows the word 'SET' in the top line and the word 'COMS' in the bottom line.</p>	<p>The RS485 port can be used for communications using Modbus RTU protocol. Parameters such as Address, Baud rate, Parity, Stop bit can be selected. Long press  to enter the Address option.</p>
---	--









4.2.1 Address

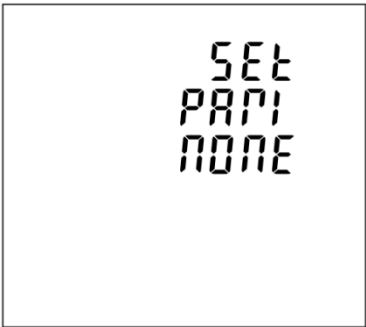

<p>The LCD display shows the word 'SET' in the top line, the word 'ADDR' in the middle line, and the number '001' in the bottom line.</p>	<p>An RS485 network can accommodate up to 255 different devices, each identified by an address. Modbus address range 001~247 Default 001</p> <p>Long press  to enter the selection routine, the address setting will flash. Use  and ,  to set the address with the range 001~247. And press  for confirmation.</p>
---	--

4.2.2 Baud rate







	<p>Baud rate options: 2400 4800 9600 19200 38400 (bps). Default: 9600bps</p> <p>From the Set-up menu, Use  and  to select the Baud rate options.</p> <p>Long press  to enter the selection routine. The Baud Rate setting will flash.</p> <p>Use  and  to choose Baud Rate.</p>
	<p>Example shows: SET Baud rate 19200 (bps)</p> <p>And long press  for confirmation.</p>



4.2.3 Parity

	<p>Parity Options: NONE, EVEN, ODD. Default Parity : NONE Note that if parity is set to ODD or EVEN, Stop Bits will be set to 1 and cannot be changed.</p> <p>From the Set-up menu, Use  and  to select the Parity options.</p> <p>Long press  to enter the selection routine. The Parity setting will flash. Use  and  to choose Parity.</p>
	<p>Example shows: Set Parity: EVEN</p> <p>And long press  for confirmation. Press  to return the main set up menu.</p>



	<p>Example shows: Set Parity: Odd</p> <p>And long press  for confirmation. Press  to return the main set up menu.</p>
---	---

4.2.4 Stop bit

	<p>Stop Bit options: 1 or 2. Default Stop Bit : 1 Note that if parity is set to ODD or EVEN, Stop Bits will be set to 1 and cannot be changed.</p> <p>From the Set-up menu, Use  and  to select the Stop Bit options.</p> <p>Long press  to enter the Stop Bit routine. The Stop Bit setting will flash. Use  and  to choose Stop Bit.</p>
---	---

	<p>Example shows Set Stop bit 2</p> <p>And long press  for confirmation. Press  to return the Communication set up menu.</p>
---	--

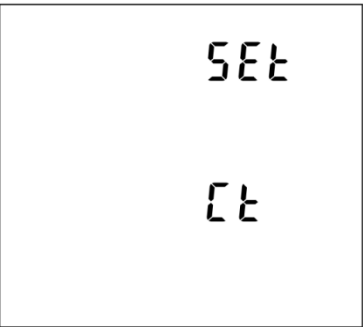
4.3 CT

	<p>From the main Set-up menu, Use  and  to select the CT option.</p>
---	--

4.3.1 CT1

	<p>Set primary current input the meter Options: 1~9999 Default CT1: 5A</p> <p>Long press to enter the CT1 routine. Press for 2s, the CT1 setting will flash. Use and to choose CT1 with 1~9999.</p> <p>And long press for confirmation.</p>
	<p>Example shows : Set CT1 100A</p> <p>And press for confirmation. Press to return the CT set up menu.</p>

4.4 PT

	<p>The PT option sets the secondary voltage of the voltage transformer (PT) that give into the meter and the PT rate between the primary voltage to the secondary voltage.</p> <p>For example: if the PT connect to the meter is 10000/100V (Primary voltage is 10000V, secondary voltage is 100V), then the PT rate is 100.</p> <p>Long press to enter the PT2 routine. Press , the PT2 setting will flash.</p> <p>Use and , to choose PT2 with 174~480.</p>
--	--

4.4.1 PT2

	<p>Set secondary voltage input the meter Range: 100V ~ 480V Default: 230V</p> <p>And long press for confirmation.</p>
--	--

4.4.2 PT1

	<p>Set primary voltage input the meter Range: 174V ~ 500000V Default: 400V</p> <p>Then press to enter the PT2 routine. press for 2s, the PT2 setting will flash. Use and , to select PT2. And long press for confirmation. Press to return the PT set up menu.</p>
--	--

4.5 Pulse

This option allows you to configure the pulse output. The output can be set to provide a pulse for a defined amount of energy active or reactive.

	<p>This option sets the pulse output type, pulse rate, duration time.</p> <p>From the Set-up menu, Use and to select the Pulse option.</p>
--	--

4.5.1 Pulse output1

	<p>Pulse output 1 setting Output type options: total kWh, import kWh, export kWh, total kVarh, import kVarh, Export kVarh. Default: total kWh</p> <p>Long press to enter the PT Pulse Output 1 routine.</p>
--	--

	<p>Example shows: Pulse Output 1: import kWh Options: total kWh, total kVarh, imp kWh, exp kWh, imp kVarh, exp kVarh.</p> <p>press for 2s, the setting will flash. and to choose Options. And long press for confirmation.</p>
--	--

4.5.2 Pulse rate

<p>The LCD display shows the menu 'SET PULS RATE' with the value '0.001' at the bottom.</p>	<p>Pulse rate options: 0.001 , 0.01 , 0.1 , 1, 10, 100, 1000 kWh / kVarh per Pulse Default : 0.001 kWh / kVarh per pulse</p> <p>Use and to select Pulse Rate option. Long press , the setting will flash. Use and to choose Options. And long press for confirmation.</p>
<p>The LCD display shows the menu 'SET PULS RATE' with the value '0.01' at the bottom.</p>	<p>Example shows: Pulse rate: 0.01</p>

4.5.3 Pulse Duration

<p>The LCD display shows the menu 'SET PULS TIME' with the value '100' at the bottom.</p>	<p>Pulse Duration time option 200, 100, 60mS Default : 100mS</p> <p>Use and to enter Pulse duration routine. Long press , the setting will flash. Use and to choose Options. And long press for confirmation. Press to return the Pulse Duration set up menu.</p>
<p>The LCD display shows the menu 'SET PULS TIME' with the value '200' at the bottom.</p>	<p>Example shows: Pulse time 200mS</p>
<p>The LCD display shows the menu 'SET PULS TIME' with the value '60' at the bottom.</p>	<p>Example shows: Pulse time 60mS</p>

4.6 Demand

	<p>This sets the period in minutes over which the current and power readings are integrated for maximum demand measurement. The options are: OFF, 5, 8, 10, 15,30, 60 minutes.</p> <p>From the Set-up menu, Use and to select the Demand option.</p>
--	--

4.6.1 Demand interval time

	<p>The screen will show the currently selected integration time. Default is 60</p> <p>Long press to enter the DIT routine. Press for 2s, the setting will flash. Use and to choose Options. And long press for confirmation.</p>
--	---

4.6.2 Demand method

	<p>The screen shows the Demand calculation method: Slid Options: Fix and Slid</p> <p>Use and to enter Demand calculation method.</p>
	<p>Long press to enter the routine. The setting will flash. Use and to choose Options. And long press for confirmation. Press to return the Demand set up menu.</p>

4.7 Time

	<p>This option sets the backlight lasting time and display scroll time.</p> <p>From the Set-up menu, Use and to select the Time option.</p>
--	---



4.7.1 Backlight time

	<p>The meter provides a function to set the backlit lasting time. Options: ON/OFF/5/10/30/60/120 minutes. Default: 60 If it is seated as 5, the backlit will be off in 5 minutes. Note: if it is set as ON, the backlit will always be on.</p> <p>Long press to enter the Backlit time routine. Press for 2s, the setting will flash. Use and to choose Options. And long press for confirmation.</p>
--	--



4.7.2 Display scroll time

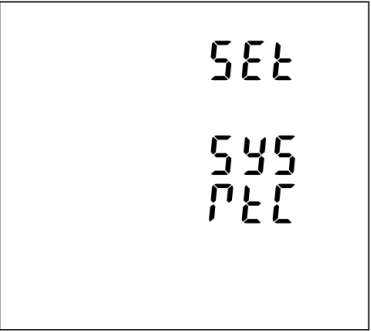

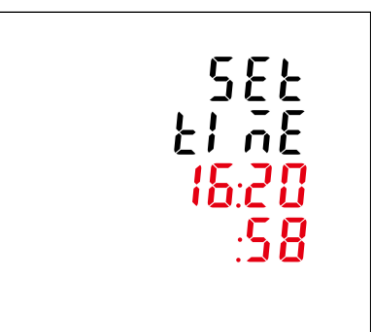
	<p>The meter provides a function to set the Display scroll time. Options: 1~255s Default: 5 If it is seated as 5, the display will scroll every 5s.</p> <p>Use and to select Display scroll time option. Press for 2s, the setting will flash. Use and to choose Options. And Long press for confirmation. Press to return the Time set up menu.</p>
--	---

4.7.3 System RTC

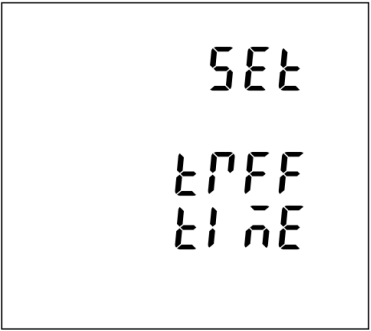

	<p>This option is to set the real time clock for the meter.</p> <p>By pressing the , to get into date and time setting.</p>
	<p>Set the date of RTC. Left picture shows 2017-Otc-1st The format is YYYY-MM-DD</p>
	<p>Set the time of RTC Left picture shows 16:20:58 The format is HH-MM-SS</p>

4.7.4 Tariff Time







	<p>This option is to set the time segments with different tariffs.</p> <p>By pressing the , to get into the time segments and tariffs setting.</p>
---	---

	<p>Set the time segments and corresponding tariffs</p> <p>Left pictures shows: Time 01 – time segment number , range from 01 to 08 06:00 – starting time of this time segment, format : HH-MM FEE1 – Tariff 1 , range 1~4.</p> <p>By pressing the  , user can set the time segment and tariff information.</p>
---	---

4.8 System

	<p>The Unit has a default setting of 3 phase 4 wire (3p4w). Use this section to set the type of electrical system. Options: 3P34,3P3W,1P2W</p> <p>From the Set-up menu, Use  and  to select the System option</p>
---	--











4.8.1 System type

	<p>The screen shows the currently selected power supply is three phase four wire</p> <p>Long press  to enter the System type routine. Press  for 2s, the setting will flash. Use  and  to choose Options. And Long press  for confirmation.</p>
---	--







	<p>Example shows: The screen shows the currently selected power supply is three phase three wire</p>
---	---

	<p>Example shows: The screen shows the currently selected power supply is single phase two wire</p>
---	---







4.8.2 System connect



	<p>This unit provides a function with Reverse connected current inputs correction setting.</p> <p>Use  and  to select the correction option.</p>
	<p>Options: Frd (forward) and rEv (reverse) The default is FRD (forward)</p> <p>Long press  to enter the Phase 1 correction. Press  for 2s, the setting will flash. Use  and  to choose Options. And long press  for confirmation.</p>
	<p>Press  enter Phase 2 correction. Press  for 2s, the setting will flash. Use  and  to choose Options. And long press  for confirmation.</p>
	<p>Press  enter Phase 3 correction. Press  for 2s, the setting will flash. Use  and  to choose Options. And long press  for confirmation. Press  to return the System set up menu.</p>

4.8.3 Change password





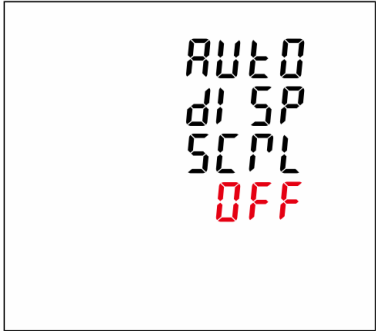





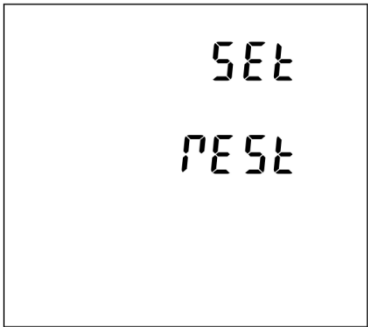

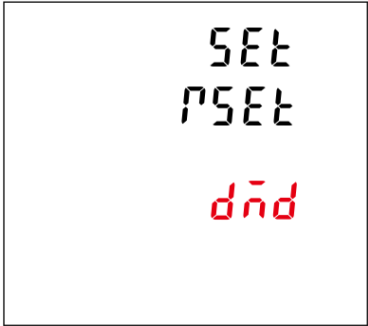

	<p>This unit provides a function with password setting. Default: 1000 Options:0000~99999</p> <p>Use  and  to select the change password option.</p>
	<p>Press  for 2s, the setting will flash. Use  and ,  to choose Options. And long press  for confirmation.</p>

4.8.4 Automatic display scroll

	<p>This unit provides a function with automatic display scroll setting. Options: on and off There are two ways:</p> <p>① Use  and  to select the automatic display scroll option. Press  for 2s, the setting will flash. Use  and  to choose options "On" or "Off". And long press  for confirmation.</p>
	<p>② Escape the Setting menu. Long press  for 2 secs. For example, the screen shows the currently selected Automatic Scroll display ON.</p>

	<p>Long press  for 2 secs, then the screen shows the currently selected Automatic Scroll display OFF.</p>
---	--

4.9 Reset

	<p>This unit provides a function with reset for Energy and Demand, and ALL.</p> <p>Use  and  to select the Reset option.</p>
	<p>Long press  to enter the Energy routine. Press  for 2s, the setting will flash, then long press  to confirm the reset.</p>
	<p>Then press  enter Demand Reset routine. Press  for 2s, the setting will flash, then long press  to confirm the reset.</p>
	<p>Then press  enter ALL Reset routine. Press  for 2s, the setting will flash, then long press  to confirm the reset.</p> <p>Press  to return the Reset set up menu.</p>

5. Specification

5.1 Measured Parameters

The unit can monitor and display the following parameters of a single phase, 3-phase 3-wire or 3-phase 4-wire supply.

5.1.1 Voltage and Current

Rated Voltage Input: 3x230/400V 50Hz

Installation Category III (600V)

Rated Current input: 100mA CT

Current input range: 5%~120% I_b

Percentage total voltage harmony distortion (THD%) for each phase to N

Percentage current harmonic distortion for each phase

Current on each phase

5.1.2 Power factor and Frequency and Max. demand

Frequency in Hz (45~66Hz)

Instantaneous power: Power 0 to 9999MW

Reactive Power 0 to 9999MVA

Volt-amps 0 to 9999 MVA

Maximum demanded power since last Demand reset Power factor

Maximum demand current, since the last Demand reset (three phase supplies only)

5.1.3 Energy Measurements

Imported active energy 0 to 9999999.9 kWh

Exported active energy 0 to 9999999.9 kWh

Imported reactive energy 0 to 9999999.9 kVAh

Exported reactive energy 0 to 9999999.9 kVAh

Total active energy 0 to 9999999.9 kWh

Total reactive energy 0 to 9999999.9 kVAh

5.2 Accuracy

- Voltage VL-N 0.5%
- Voltage VL-L 0.5%
- Current 0.5%
- Frequency 0.1
- Active power 0.5%
- Apparent power 0.5%
- Reactive power 1%
- Power factor 0.01
- Active energy EN50470-1/-3 Class C and Class B
IEC62053-21 Cl.1 or IEC62053-22 Cl.0.5S
- Reactive energy IEC62053-23 Cl.2
- THD 1%

5.3 Display

Liquid crystal display with backlit (360° full viewing angles)

4 lines, 4 digits per line to show electrical parameters

5th line, 8 digits to show energy

Bar graph for power indication

Display update time: 1 sec. for all parameters

Display scrolling: automatic or manual (Programmable)

5.4.1 Pulse Output

The pulse outputs can be set to generate pulses to represent kWh/kVarh

Pulse constant: 0.001/0.01/0.1/1/10/100/1000 kwh or kVarh per Pulse

Pulse width: 200/100/60 ms.

The pulse output is passive type, complies with IEC62053-31 Class A.

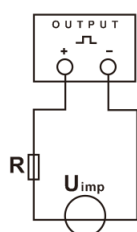

ATTENTION: Pulse output must be fed as shown in the wiring diagram below. Scrupulously respect polarities and the connection mode. Opto-coupler with potential-free SPST-NO Contact. Contact range:5~27VDC Max. current Input:27mA DC.

5.4.2 Modbus RTU

Interface standard and protocol: RS485 and MODBUS RTU

Communication address: 1~247

Transmission mode: Half duplex

Data type: Floating point

Transmission distance: 1000m Maximum

Transmission speed: 2400bps~38400bps

Parity: None (default), Odd, Even

Stop bits: 1 or 2

Response time: <100 mS

For Modbus RTU, the following RS485 communication parameters can be configured from the Set-up menu:

Baud rate 2400, 4800, 9600, 19200, 38400 bps

Parity none/odd/even

Stop bits 1 or 2

RS485 network address *nnn* – 3-digit number, 001 to 247

5.4.3 Environment

- Operating temperature -25°C to +55°C
- Storage temperature -40°C to +70°C
- Relative humidity 0 to 95%, non-condensing
- Altitude <2000 meters
- Vibration 10Hz to 50Hz, IEC 60068-2-6, 2g
- Pollution degree II
- Protection against dust and water IP51(indoor)
- Mechanical environment M1

- EMC environment E1

5.4.4 Mechanics

- DIN rail dimensions 96x 96mm (WxH)
- Mounting Panel mounting
- Material Self-extinguishing UL 94 V-0

6. Maintenance

In normal use, little maintenance is needed. As appropriate for service conditions, isolate electrical power, inspect the unit and remove any dust or other foreign material present. Periodically check all connections for freedom from corrosion and screw tightness, particularly if vibration is present.

The front of the case should be wiped with a dry cloth only. Use minimal pressure, especially over the viewing window area. If necessary, wipe the rear case with a dry cloth. If a cleaning agent is necessary, isopropyl alcohol is the only recommended agent and should be used sparingly. Water should not be used. If the rear case exterior or terminals should be contaminated accidentally with water, the unit must be thoroughly dried before further use. Should it be suspected that water might have entered the unit, factory inspection and refurbishment is recommended.

In the unlikely event of a repair being necessary, it is recommended that the unit be returned to the factory or nearest Eastron distributor.

7 Installation

The unit may be mounted in a panel of any thickness up to a maximum of 3 mm. Leave enough space behind the instrument to allow for bends in the connection cables. The unit is intended for use in a reasonably stable ambient temperature within the range -25°C to +55°C. Do not mount the unit where there is excessive vibration or in excessive direct sunlight.

7.1 Safety

The unit is designed in accordance with IEC 61010-1:2010 – Permanently connected use, Normal condition. Installation category III, pollution degree 2, basic insulation for rated voltage.

7.2 EMC Installation Requirements

Whilst this unit complies with all relevant EU EMC (electro-magnetic compatibility) regulations, any additional precautions necessary to provide proper operation of this and adjacent equipment will be installation dependent and so the following can only be general guidance:

Avoid routing wiring to this unit alongside cables and products that are, or could be, a source of interference.

The auxiliary supply to the unit should not be subject to excessive interference. In some cases, a supply line filter may be required.

To protect the product against incorrect operation or permanent damage, surge transients must be controlled. It is good EMC practice to suppress transients and surges at the source. The unit has been designed to automatically recover from typical transients; however in extreme circumstances it may be necessary to temporarily disconnect the auxiliary supply for a period of greater than 10 seconds to restore correct operation.

Screened communication leads are recommended and may be required. These and other connecting leads may require the fitting of RF suppression components, such as ferrite absorbers, line filters etc., if RF fields cause problems.

It is good practice to install sensitive electronic instruments that are performing critical functions in EMC enclosures that protect against electrical interference causing a disturbance in function.

Warning



- During normal operation, voltages hazardous to life may be present at some of the terminals of this unit. Installation and servicing should be performed only by qualified, properly trained personnel abiding by local regulations. Ensure all supplies are de-energized before attempting connection or other procedures.
- Terminals should not be user accessible after installation and external installation provisions must be sufficient to prevent hazards under fault conditions.
- This unit is not intended to function as part of a system providing the sole means of fault protection - good engineering practice dictates that any critical function be protected by at least two independent and diverse means.
- The unit does not have internal fuses therefore external fuses must be used for protection and safety under fault conditions.
- Never open-circuit the secondary winding of an energized current transformer.
- This product should only be operated with CT secondary connections Earthed.
- If this equipment is used in a manner not specified by the manufacturer, protection provided by the equipment may be impaired.

Auxiliary circuits (communication & relay outputs) are separated from metering inputs and 110-400V auxiliary circuits by at least basic insulation. Such auxiliary circuit terminals are only suitable for connection to equipment which has no user accessible live parts. The insulation for such auxiliary circuits must be rated for the highest voltage connected to the instrument and suitable for single fault condition. The connection at the remote end of such auxiliary circuits should not be accessible in normal use. Depending on application, equipment connected to auxiliary circuits may vary widely.

7.3 Declaration of Conformity (for the MID approved version meter only)

We Zhejiang Eastron Electronic Co.,Ltd. declare under our sole responsibility as the manufacturer that the poly phase multifunction electrical energy meter "Smart X96 Series" correspond to the production model described in the EU-type examination certificate and to the requirements of the Directive 2014/32/EU EU type examination certificate number 0120/SGS0288. Identification number of the NB0120.

8. Dimensions

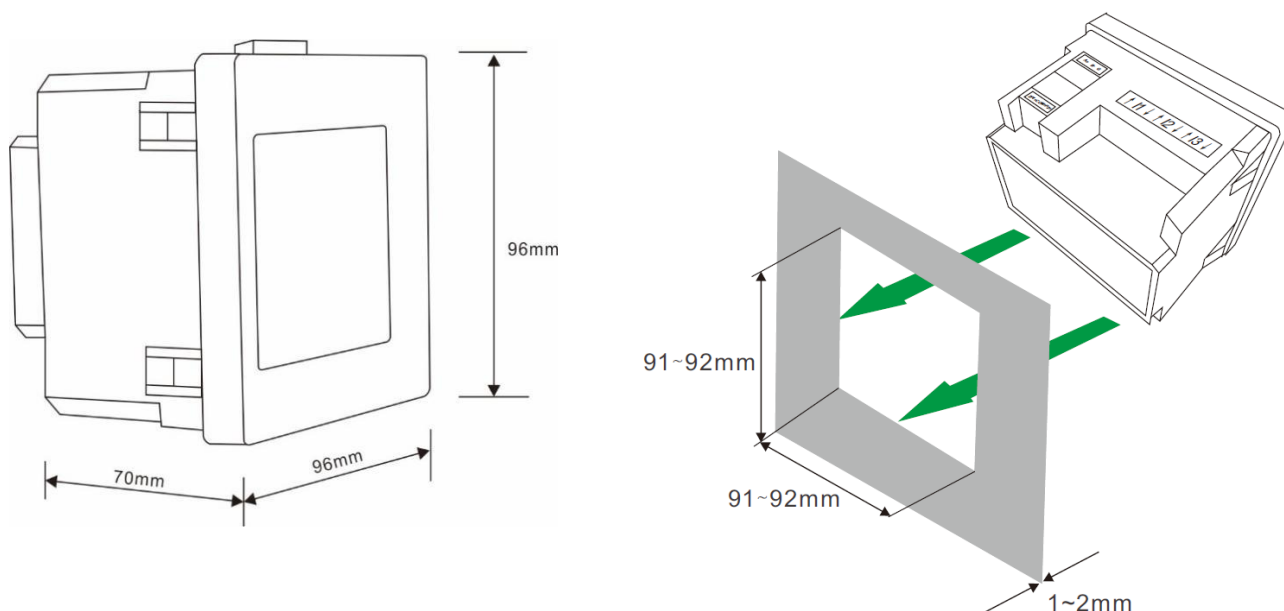

9. Wiring Diagram

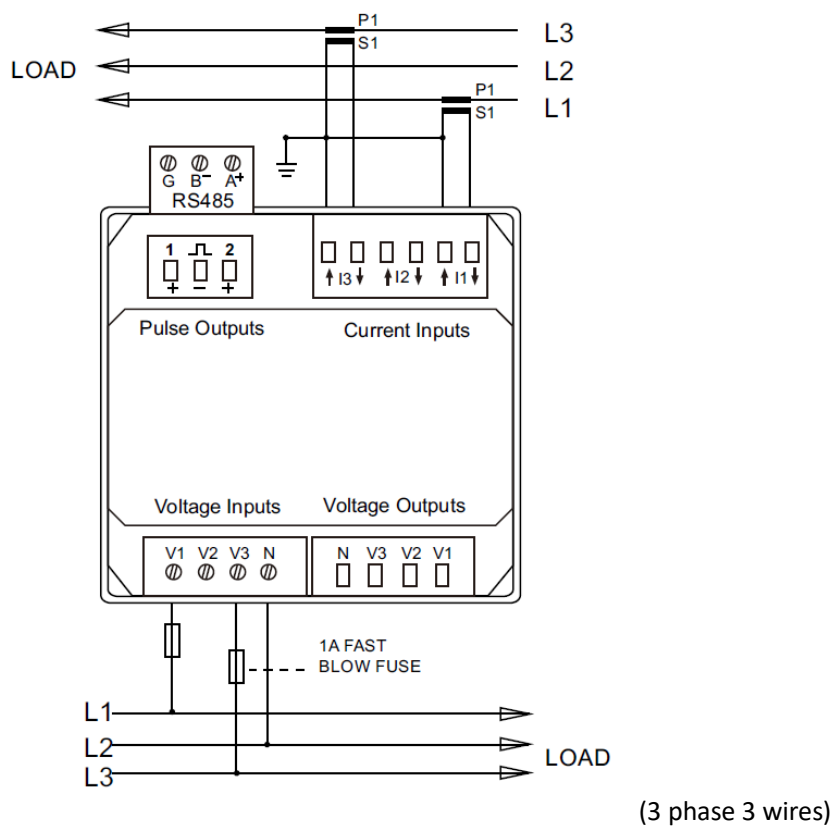
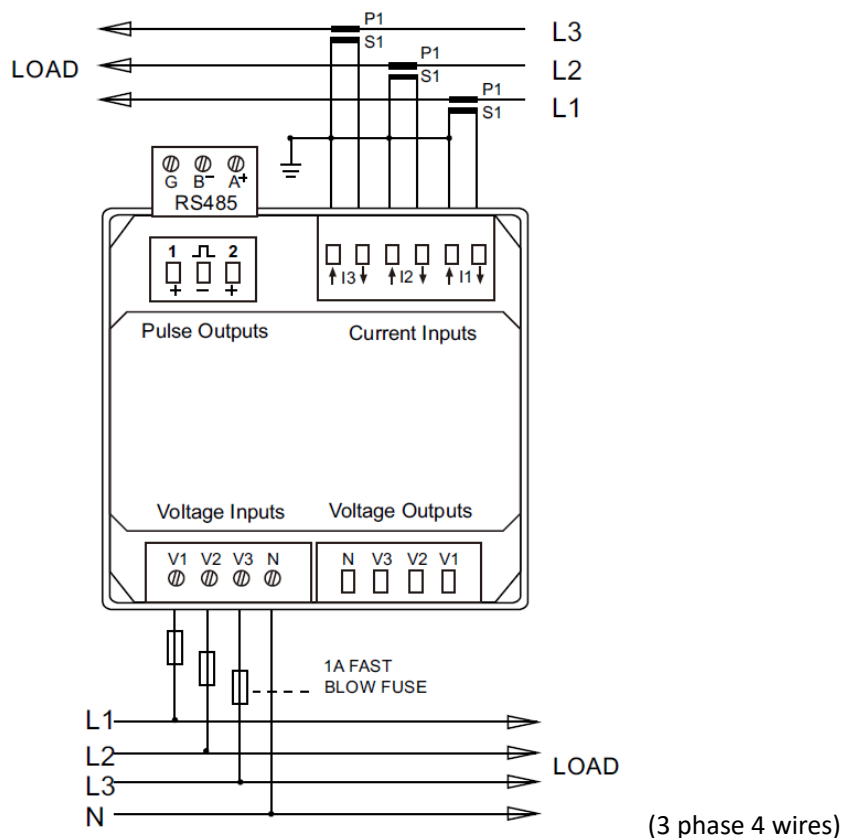

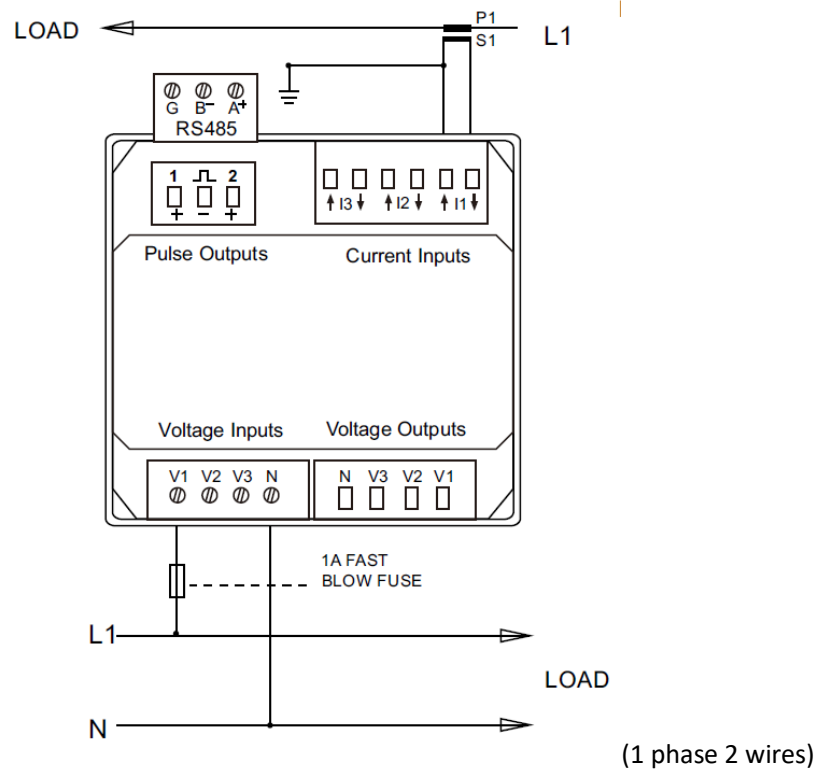

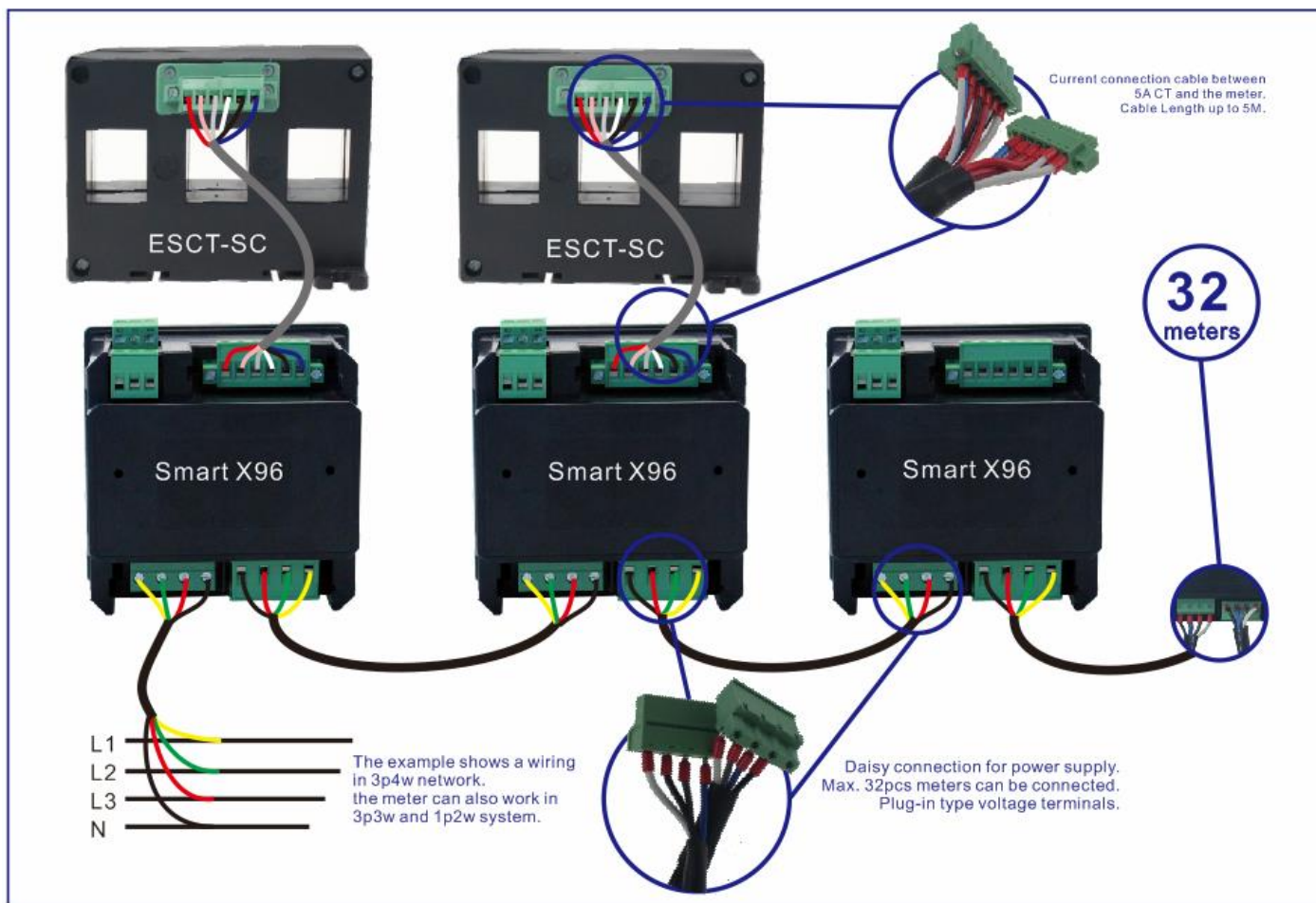

Zhejiang Eastron Electronic Co.,Ltd.
 No.1369,Chengnan Rd. Jiaxing, Zhejiang, 314001, China
 Tel: +86-573-83698881 83698882
 Fax: +86-573-83698883
 Email: sales@eastrongroup.com
www.eastron.com.cn
www.eastrongroup.com